

Stalky Stalker

a design by roberto vañecek



EL USO COMERCIAL DE ESTE DISEÑO NO ESTA AUTORIZADO

Si desea utilizar este diseño para fines comerciales,
por favor no dude en contactarme, llegaremos a un acuerdo.

Roberto Vañecek, Argentina '2008
Todos los derechos reservados.

COMMERCIAL USE OF THIS DESIGN IS NOT AUTHORIZED

*If you wish to use this design for commercial purposes,
please don't hesitate to contact me, we will reach an arrangement.*

Roberto Vañecek, Argentina '2008
All rights reserved.

robmdq@yahoo.com.ar
rob@bajamarteam.com.ar

Introducción

Introduction

Diseñé este barrilete para el concurso organizado en Kitebuilder en Noviembre '2008

<http://www.kitebuilder.com/forums/viewtopic.php?t=7139>

Cuando lo construí usé lo que tenía a mano, tela de polipropileno (spunbond), fibra de vidrio blanda, madera; quizás lo único bueno que puse fue el tubo de fibra de carbono y los conectores FSD. Los materiales se pueden mejorar, un buen ripstop nylon (Air-X, Challenger, Norlon, Porscher, Chikara) podría ser muy bueno. Si reemplazamos la tela, por ejemplo, por un polyester laminado en policarbonato (PC-31) y se le coloca carbono en toda la estructura (Skyshark P90 para reemplazar la fibra de vidrio de Ø6mm y Skyshark P200 para reemplazar el travesaño) se podría volar este barrilete casi sin viento. (Haré esta versión en cuanto pueda).

El vuelo de este barrilete es increíblemente estable, supera incluso la estabilidad de cualquier delta que haya visto antes. El ángulo de vuelo, dependiendo del viento, puede ser de hasta 85° y no menos de 75°. Genera una considerable tracción y se comporta muy bien incluso con vientos bastante fuertes y muy arrachados (los vientos normales para mi ciudad...). ¿Será bueno para K.A.P.?

Bueno, he hecho este plano lo mejor que pude, hay técnicas que utilizo que podría enseñarlas en 2 minutos, pero me resultan muy difíciles de explicar por escrito, por eso en vez de palabras acá les doy un montón de dibujos.

Que lo disfruten!

Listado de materiales

Material list

Toda la tela se considera de 1,50m de ancho.

1m	Tela de color -alas-
40cm	Tela negra -paneles centrales y bolsillos del borde de ataque-
45cm	Tela blanca -quillas-
10m	Cinta al bias de polyester (2cm de ancho)
	Material para refuerzos (dacrón, mylar, etc.)
1,5m	Cuerda de dacrón Ø 1,0mm
4,0m	Cuerda de dacrón Ø 1,5mm
0,5m	Cuerda elástica
2	Varillas fibra de vidrio de Ø 6mm x 100cm
2	Varillas fibra de vidrio de Ø 6mm x 145cm
1	Tubo de fibra de carbono de Ø8mm x 140cm (puede reemplazarse por Skyshark P300)
2	Capuchones plásticos de 6mm
2	Capuchones FSD de 6mm (pueden usarse comunes perforados)
2	Capuchones FSD de 8mm (pueden usarse comunes perforados)

I've designed this kite for the Kitebuilder's forums contest in November '2008.

<http://www.kitebuilder.com/forums/viewtopic.php?t=7139>

When I've built it I've used just what I've had at hand at the moment, polypropellene fabric (spunbond), soft fiberglass rods, wood; maybe the only good stuff I've used was the pultruded carbon tube and the FSD connectors. The materials can be improved, a nice ripstop nylon (Air-X, Challenger, Norlon, Porscher, Chikara) could be very good. If we replace the fabric, for example, for a polycarbonate coated polyester (PC-31) and then we put carbon for all the frame (Skyshark P90 tubes instead the Ø6mm fiberglass and Skyshark P200 instead the Ø8mm pultruded carbon tube) then we might fly this kite almost without wind. (I'll do this version when I can).

This kite in flight is amazingly steady, it performs even better than any delta I have seen before. The flying angle, depending on wind conditions, can be up to 85° and no less than 75°. It provides quite a pull and has a very good behavior even in quite strong and very gusty winds (the normal winds for my city...) May be good for K.A.P.?

Well, I've done these plans the best I could, there are techniques wich I use that could be taught in 2 minutes, but they become very difficult to explain on paper, so instead of words I give you a lot of drawings.

Enjoy!

All fabric is considered to be 1.50m wide

1m	Color fabric -wings-
40cm	Black fabric -center pannels plus leading edge spar pockets-
45cm	White fabric -keels-
10m	polyester edge binding tape (2cm wide)
	Reinforcement material (dacron, mylar, etc.)
1.5m	Ø1.0mm dacron string
4.0m	Ø1.5mm dacron string
0.5m	Elsatic cord
2	Fiberglass rods Ø6mm x100cm
2	Fiberglass rods Ø6mm x145cm
1	Pultruded carbon fiber tube Ø8mm x140cm (can replace it for Skyshark P300)
2	Plastic end caps Ø6mm
2	FSD end caps Ø 6mm (can use normal end caps, drilling them)

Medidas de los paneles (no incluyen márgenes de costura)

Pannel measurement (does not include seam allowances)

Alas

Wings

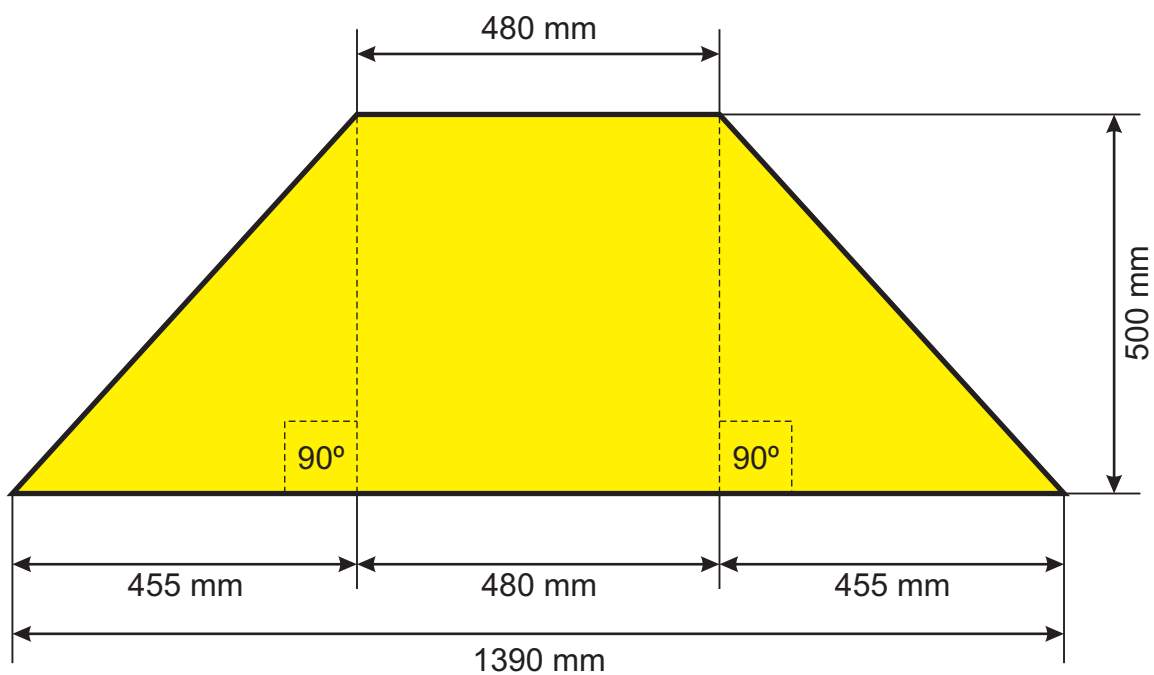

Paneles centrales

Center pannels

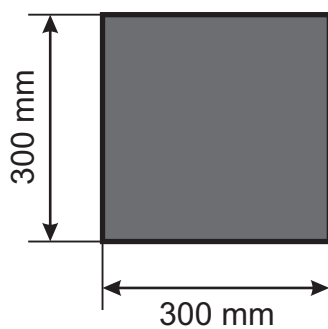

Quillas

Keels

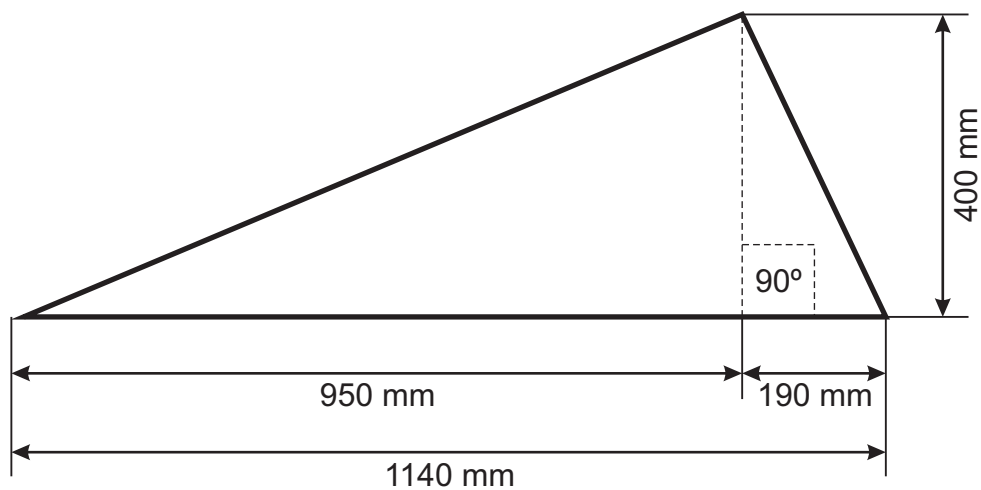

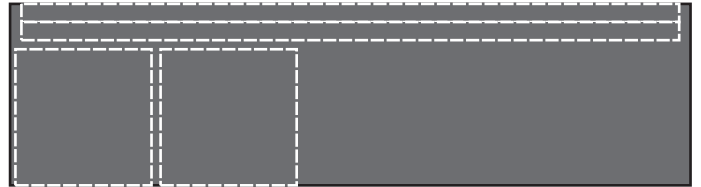
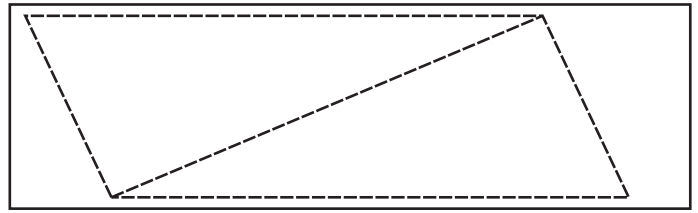
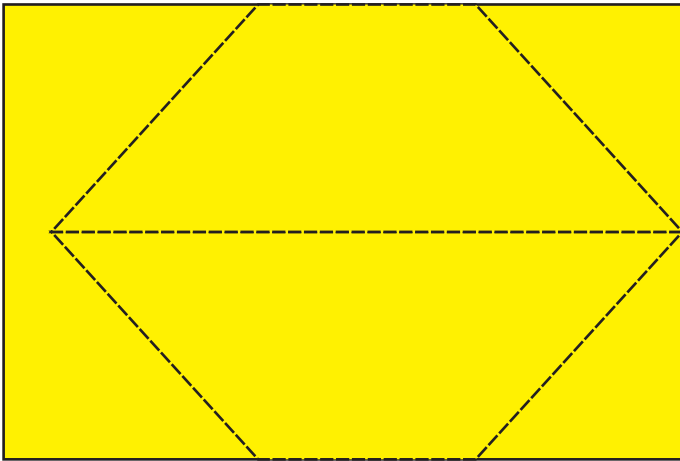

Márgenes de costura, ribeteados y refuerzos

Seam allowances, edge bindings and reinforcements

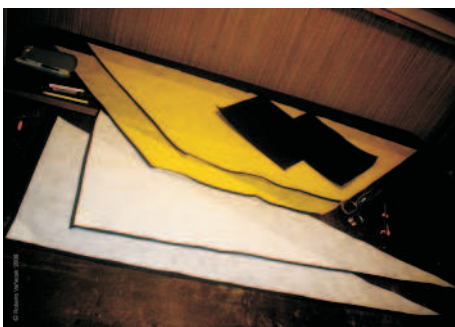
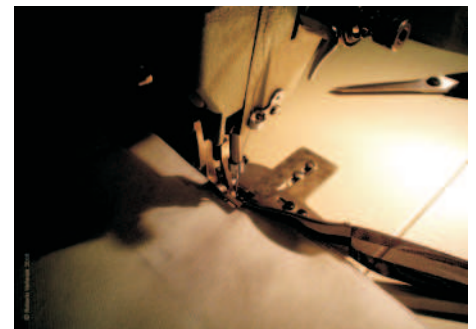
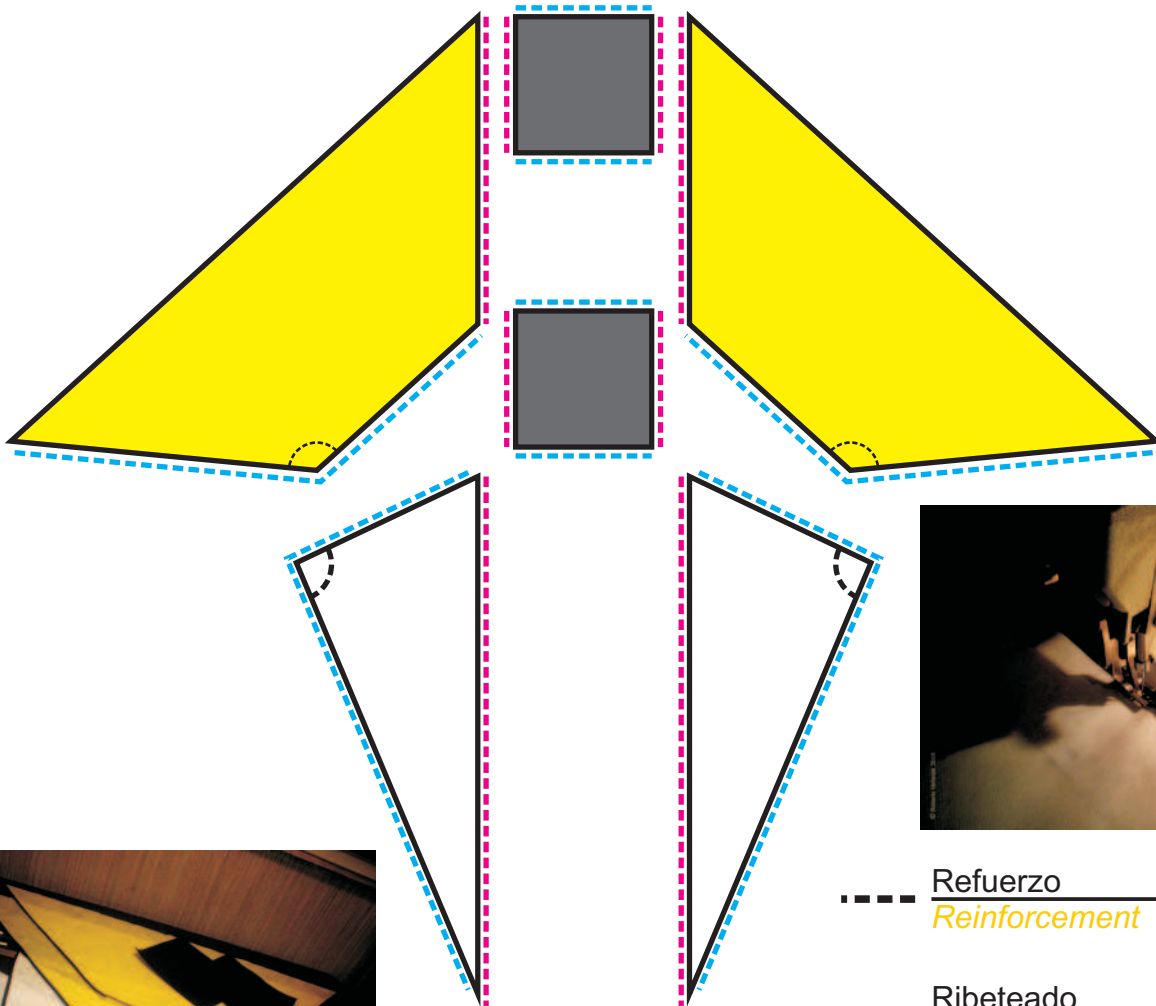

- Refuerzo
Reinforcement
- - - Ribeteado
Edge binding
- - - Margen de costura
Seam allowance

Método para coser los bolsillos de los largueros
Method used to sew together the longeron's pockets

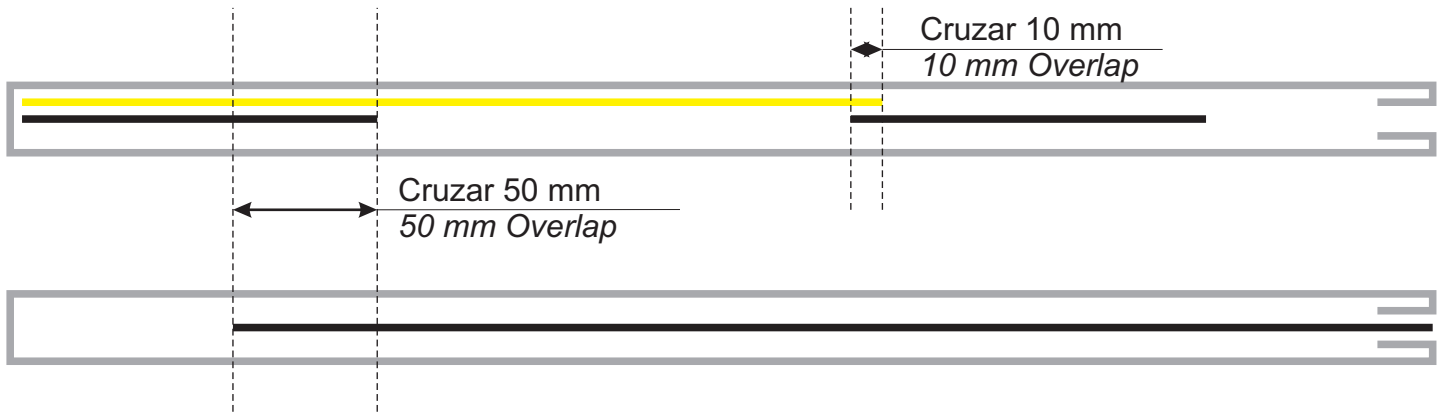

Colocación de la primera ala
First wing attachment

Colocación de la segunda ala
Second wing attachment

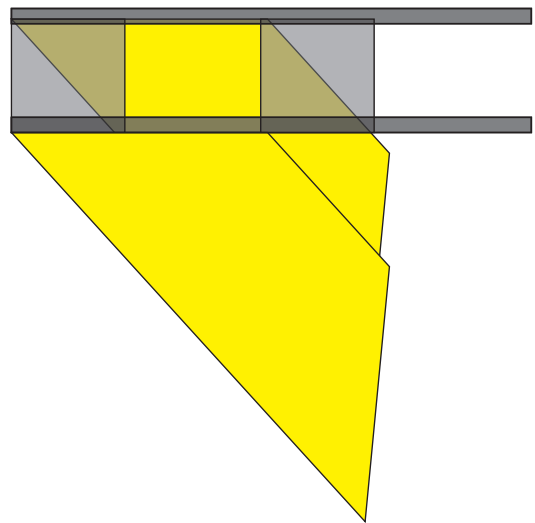
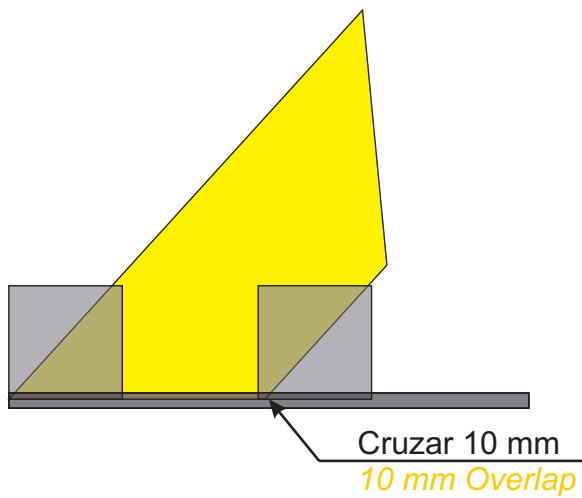

Colocación de las quillas
Keels attachment

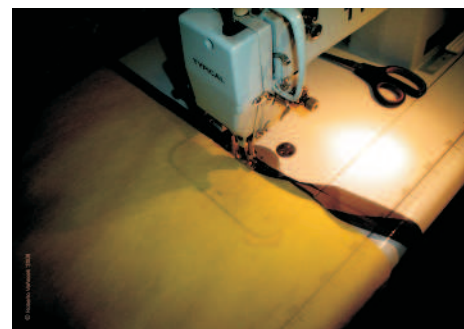
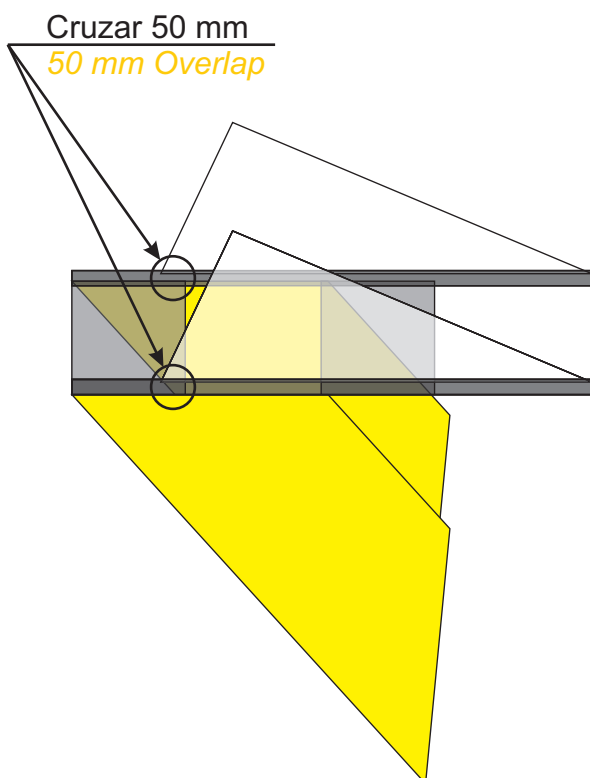

Vista frontal de las costuras
Seam's front view

